



CONTENTS

CCF introduction	4
Treetex range guide introduction	6
Treetex mineral fibre ceiling tiles	7
TX24 exposed grid	10
Concealed grid systems	12
Fire barrier solutions	20
Modular lighting solutions	24
Aluminium perimeter trims and transition profiles	30
Shadow battens	32
Primary suspension systems	33
Ceiling fixings and accessories	34
Access panels	38
Laser levels and temporary surface protection	40
Acoustic insulation pads for metal tile systems	41
Other creative solutions from CCF	42



CCF offer a complete service to the specialist interiors industry involved in ceilings, drywall, screeding, insulation, partitioning and fire protection. We hold massive stocks of one of the best core product ranges in the industry, at prices which are competitive. And because of our large stock holdings, you can rely on CCF to deliver on time, in full, every time.

Our entire product range is backed by specialist staff who are committed to giving you the best possible service and putting you first. Above all we're dedicated to delivering on our commitments and keeping promises at all times.

- **A core product range that can be supplied from stock**
- **Deliveries on time and in full**
- **Staff who understand and always put you first**
- **Service you can trust and advice you can rely on**
- **Competitive pricing**



Ceilings

A comprehensive range of mineral, metal and plaster tiles, grid systems and accessories from major manufacturers.

Drywall

A complete range of dry lining products available nationally from the UK's leading distributor.

Screeding

Nationwide distribution of a broad but specialist product range coupled with in-house technical expertise is now available to all CCF customers.

Insulation

A range of specialist insulation branches with huge stocks and fast, reliable delivery.

Partitioning

A versatile range providing attractive, economical solutions with acoustic and fire performance where required.

Fire Protection

Fire protection and fire barrier products from leading manufacturers and a range of metal products, fixings and access panels.

www.ccfltd.co.uk

TREETEX RANGE GUIDE

Treetex is one of the most established brands in the business with over 75 years experience of providing ceiling solutions to UK contractors. Now with a new extended range, Treetex can provide installers with an even more comprehensive choice of suspended ceiling solutions.

The range now includes tiles, grid, modular lighting and access panels together with fixings and accessories for virtually every modular exposed grid ceiling installation. With the addition of three new performance tiles, the Treetex range can now provide enhanced levels of fire resistance, humidity resistance and sound attenuation.

Where appropriate, our products have been tested or assessed by independent accredited laboratories and meet the relevant British Standards. This means that installers can be confident that Treetex products are of the highest quality and will perform exactly as required.

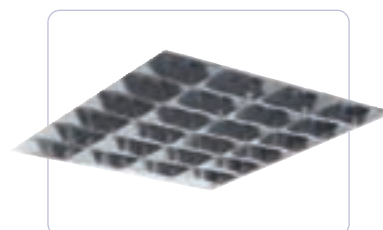
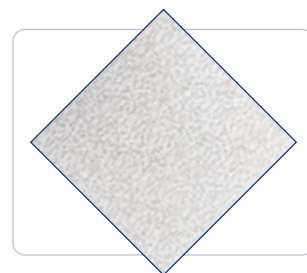

MINERAL FIBRE CEILING TILES



The Treetex tile range comprises three general purpose tiles and three tiles offering specific technical solutions. These are available in various module sizes, face patterns and edge details.

The entry level general purpose tile is **Spintone**. **Sahara** offers mid range performance whilst **Superior** provides solutions for more demanding general purpose applications.

Where a specific technical performance is required, Treetex offers **Mezzanine FR** for fire rated ceiling solutions, **Acoustimax dB** for sound attenuation and acoustical control and **Aquamax RH** for applications where high humidity resistance is required.

In fire performance applications always refer to the Treetex Tile and Grid Fire Resistance data sheet. For general technical information there are also separate data sheets available for each tile. Please contact your local branch of CCF to pick up a copy or download from www.ccfltd.co.uk.



MINERAL FIBRE CEILING TILES

TREETEX – SPINTONE 180 & 360

PRODUCT CODE PRODUCT DESCRIPTION

614685	TREETEX SPINTONE 180 FISSURED SQUARE EDGE 600 x 600 x 12mm 5.76m ² 16 TILES CTN
628963	TREETEX SPINTONE 180 FISSURED SQUARE EDGE 1200 x 600 x 12mm 7.20m ² 10 TILES CTN
614686	TREETEX SPINTONE 360 FISSURED SQUARE EDGE 600 x 600 x 12mm 5.76m ² 16 TILES CTN

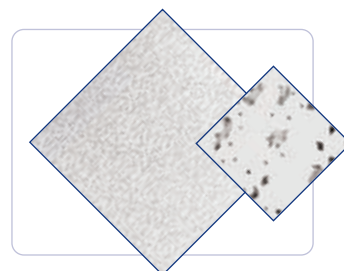

TREETEX – SAHARA PLAIN

PRODUCT CODE PRODUCT DESCRIPTION

614691	TREETEX SAHARA PLAIN SQUARE EDGE 600 x 600 x 14mm 4.32m ² 12 TILES CTN
614692	TREETEX SAHARA PLAIN SQUARE EDGE 1200 x 600 x 14mm 7.20m ² 10 TILES CTN
614693	TREETEX SAHARA PLAIN TEGULAR T24 600 x 600 x 14mm 4.32m ² 12 TILES CTN
614694	TREETEX SAHARA PLAIN TEGULAR T15 600 x 600 x 14mm 4.32m ² 12 TILES CTN

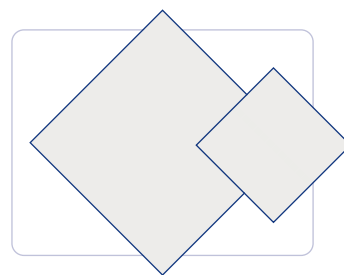

TREETEX – SAHARA PERFORATED

PRODUCT CODE PRODUCT DESCRIPTION

614695	TREETEX SAHARA PERF SQUARE EDGE 600 x 600 x 14mm 4.32m ² 12 TILES CTN
614696	TREETEX SAHARA PERF SQUARE EDGE 1200 x 600 x 14mm 7.2m ² 10 TILES CTN
614697	TREETEX SAHARA PERF TEGULAR T24 600 x 600 x 14mm 4.32m ² 12 TILES CTN
614698	TREETEX SAHARA PERF TEGULAR T15 600 x 600 x 14mm 4.32m ² 12 TILES CTN

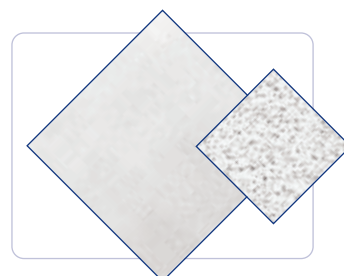

TREETEX – SUPERIOR PLAIN

PRODUCT CODE PRODUCT DESCRIPTION

545126	TREETEX SUPERIOR PLAIN SQUARE EDGE 600 x 600 x 15mm 4.32m ² 12 TILES CTN
282413	TREETEX SUPERIOR PLAIN TEGULAR T24 600 x 600 x 15mm 3.60m ² 10 TILES CTN

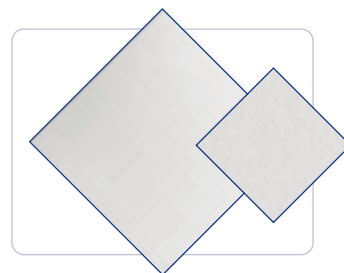

MINERAL FIBRE CEILING TILES

TREETEX – MEZZANINE FR

PRODUCT CODE	PRODUCT DESCRIPTION
547800	TREETEX MEZZANINE FR FISSURED 180 SQUARE EDGE 600 x 600 x 15mm 4.32m ² 12 TILES CTN
547810	TREETEX MEZZANINE FR FISSURED 180 SQUARE EDGE 1200 x 600 x 15mm 5.76m ² 8 TILES CTN
547187	TREETEX MEZZANINE FR FISSURED 180 TEGULAR T24 600 x 600 x 15mm 3.60m ² 10 TILES CTN

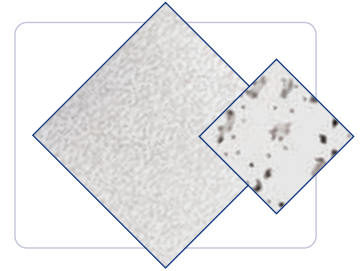

TREETEX – ACOUSTIMAX DB

PRODUCT CODE	PRODUCT DESCRIPTION
972993	TREETEX ACOUSTIMAX DB PERF SQUARE EDGE 600 x 600 x 20mm 2.88m ² 8 TILES CTN
973051	TREETEX ACOUSTIMAX DB PERF TEGULAR T24 600 x 600 x 20mm 2.88m ² 8 TILES CTN

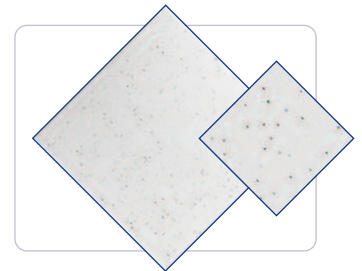

TREETEX – AQUAMAX RH

PRODUCT CODE	PRODUCT DESCRIPTION
973055	TREETEX AQUAMAX RH PERFORATED SQUARE EDGE 600 x 600 x 15mm 4.32m ² 12 TILES CTN

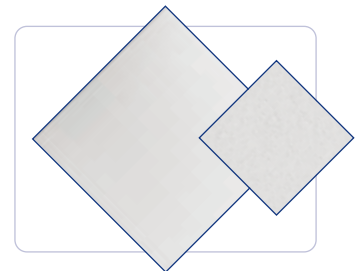

Controlled Access

See range of Ceiling Access Panels for Exposed Grid Systems on page 38

Modular Lighting

For a range of easy to install, off the shelf recessed modular luminaires and other lighting accessories see pages 24-27

Cavity Fire Barriers

For a range of cavity fire barrier solutions for installation behind suspended ceilings see pages 20-23

Fire Canopies for Lights

For a range of Fire Canopies required to maintain the integrity of a fire protective ceiling membrane see page 29

Plywood Yokes

For accommodation of downlighters or surface mounted lighting or other services see our range of Lighting Yokes on page 26

Ventilation/Natural Light

For air pressure dissipation and natural light solutions see Egg Crate Panel options on page 28

TX24 SUSPENSION GRID



To complement the Treetex tile range, TX24 grid is the ideal choice. Treetex TX24 grid is a 24mm wide exposed grid system and is compatible with most industry standard modular lay in ceiling tiles. There is a technical data sheet available to help with installation and grid loadings. When used with the appropriate Treetex tile, the ceiling solution will exceed the one hour requirement for fire protection to steel beams, timber floors and mezzanine floors. In fire resistance applications, always refer to the Treetex Fire resistance technical data sheets for the correct tile and grid choice and installation methods. Treetex ceiling systems have been independently tested and provide compliance with the appropriate fire test authority. Other grid sizes and trims are also available from CCF.

The TX24 technical data sheet is shown below. For your copy, please contact your local branch of CCF or download at www.ccf ltd.co.uk.



MAIN RUNNER

PRODUCT CODE	PRODUCT DESCRIPTION
656340	TREETEX TX24 MAIN RUNNER 3700mm WHITE 20 LENGTHS PER CTN

BUTT CUT CROSS TEE

PRODUCT CODE	PRODUCT DESCRIPTION
656343	TREETEX TX24 BUTT CUT CROSS TEE 1200mm WHITE 38mm DEEP 60 LENGTHS PER CTN
656342	TREETEX TX24 BUTT CUT CROSS TEE 600mm WHITE 25mm STALK 60 LENGTHS PER CTN

PERIMETER ANGLE TRIM

PRODUCT CODE	PRODUCT DESCRIPTION
656344	TREETEX PERIMETER ANGLE TRIM WHITE 29 x 19 x 3000mm 40 LENGTHS PER CTN

Ceiling Fixings and Accessories For a range of suspension and general fixing solutions see pages 33-35

Perimeter Shadow Battens See our range of Shadow Battens on page 32

Primary Grid For heavy duty or wide span suspension solutions see page 31

CONCEALED GRID SYSTEMS

MF Ceiling System

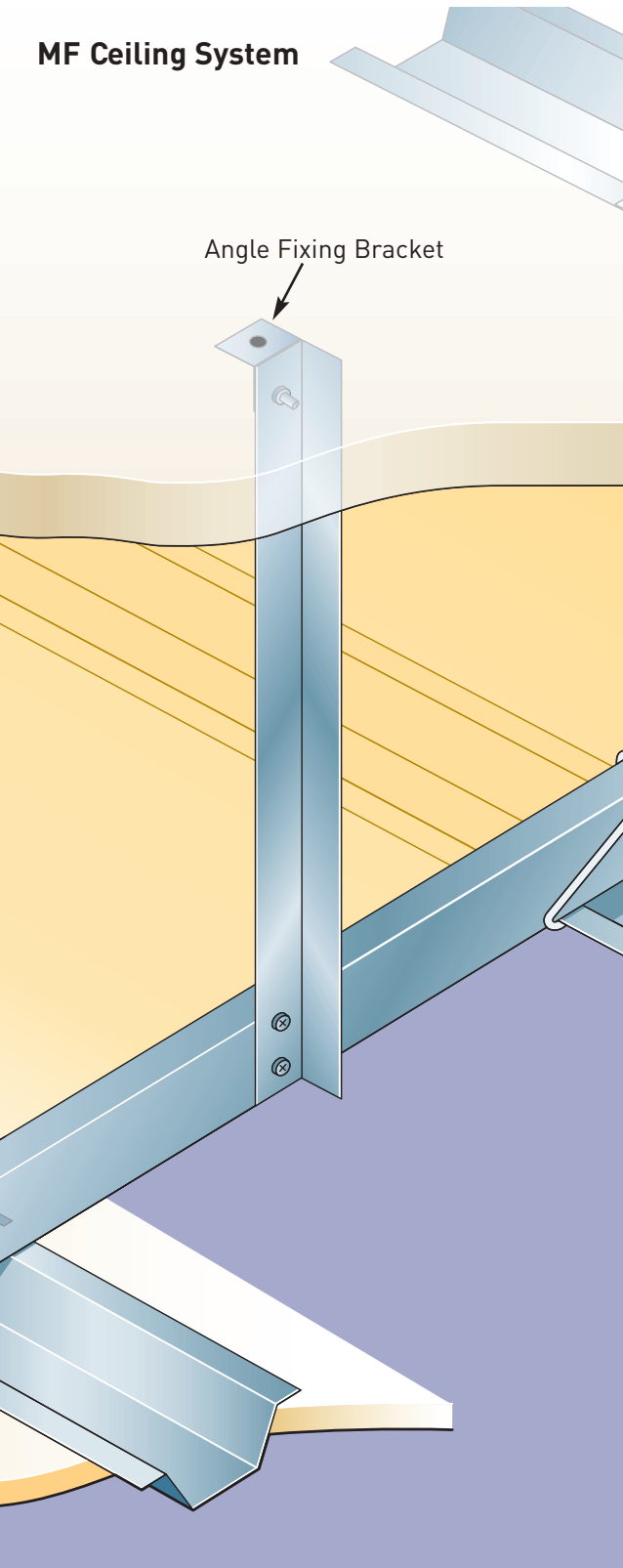

Concealed Grid Ceiling Systems

Whatever your need in concealed grid or MF Ceiling Systems, Treetex can provide the solution. The concealed grid system is designed to support mineral fibre concealed ceiling tiles.

Benefits

- All sections available ex-stock
- Accessories available
- Formed from pre-galvanised mild steel
- Easy to cut and form
- Quick and easy to assemble on site
- Easy to cut to length using tin strips

GALVANISED ANGLES AND CHANNELS

ANGLES – 90°

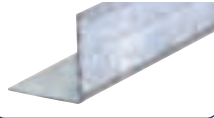

PRODUCT CODE PRODUCT DESCRIPTION

535350	ANGLE 3600 x 19 x 19mm LEG 90DEGREE SL02
535353	ANGLE 3600 x 25 x 25mm LEG 90DEGREE SL06
535359	ANGLE 3600 x 50 x 50mm LEG 90DEGREE SL13

ANGLES – 90°



ANGLES – 90°



PRODUCT CODE PRODUCT DESCRIPTION

535357	ANGLE 3600 x 50 x 25mm LEG 90DEGREE SL12
--------	--

ANGLES – 90°



CHANNELS

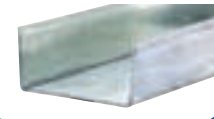

PRODUCT CODE PRODUCT DESCRIPTION

535334	CHANNEL 3600 x 38 x 19mm LEG 1.5GAUGE SU07
535336	CHANNEL 3600 x 63 x 25mm LEG 1.5GAUGE SU08
535340	CHANNEL 3600 x 75 x 38mm LEG 1.5GAUGE SU09
535344	CHANNEL 4800 x 100 x 50mm LEG 1.5GAUGE SU12
535345	CHANNEL 4800 x 100 x 50mm LEG 2.0GAUGE SU16

CHANNELS



CONCEALED GRID SYSTEMS

FULL SPRING TEE

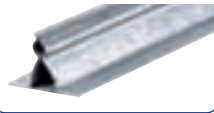

PRODUCT CODE **PRODUCT DESCRIPTION**

535376 FULL SPRING TEE 3600mm SST01

HALF SPRING TEE

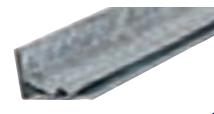

PRODUCT CODE **PRODUCT DESCRIPTION**

535378 HALF SPRING TEE 3000mm SST03

WHITE PERIMETER CHANNEL

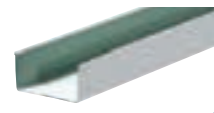

PRODUCT CODE **PRODUCT DESCRIPTION**

535381 WHITE PERIMETER CHANNEL TRIM 3000mm CF01
620260 WHITE PERIMETER CHANNEL TRIM 3050mm RAL 9010

FULL T BAR CONNECTOR

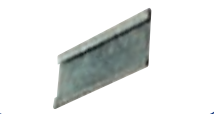

PRODUCT CODE **PRODUCT DESCRIPTION**

535382 FULL T BAR CONNECTOR AST01

BORDER WEDGE

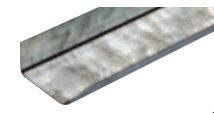

PRODUCT CODE **PRODUCT DESCRIPTION**

535383 BORDER WEDGE AST02

SPRING TO CHANNEL CONNECTOR

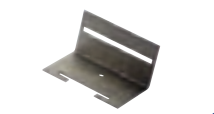

PRODUCT CODE **PRODUCT DESCRIPTION**

535384 SPRING TEE TO CHANNEL CONNECTOR AST03

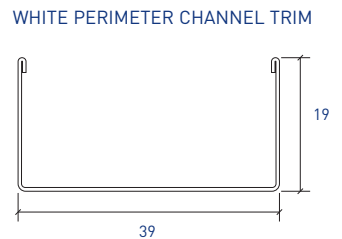
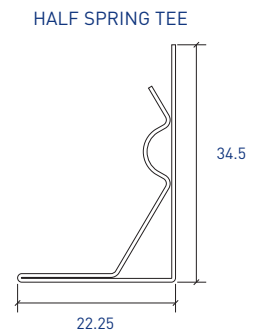
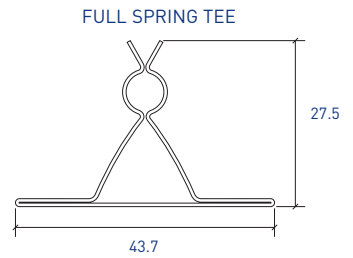

SPRING TEE AND CONCEALED GRID COMPONENTS

DEEP Z SECTION



PRODUCT CODE PRODUCT DESCRIPTION

535398 DEEP Z SECTION 3600 x 32mm SZ32

NOGGIN TEES

PRODUCT CODE PRODUCT DESCRIPTION

535399 NOGGIN TEES 600mm SZ03

C SECTION



PRODUCT CODE PRODUCT DESCRIPTION

535400 C SECTION GALVANISED 3600mm SC01

DEEP CONNECTORS



PRODUCT CODE PRODUCT DESCRIPTION

535401 DEEP CONNECTORS 19mm AZ99

DEEP CONNECTORS



PRODUCT CODE PRODUCT DESCRIPTION

535402 DEEP CONNECTORS 32mm AZ32

SPLINES



PRODUCT CODE PRODUCT DESCRIPTION

535403 SPLINES AZ03 (1000 PER PACK)

CHANNEL CLIPS



PRODUCT CODE PRODUCT DESCRIPTION

535404 PREFORMED CHANNEL CLIPS AZ06

DEEP Z SECTION

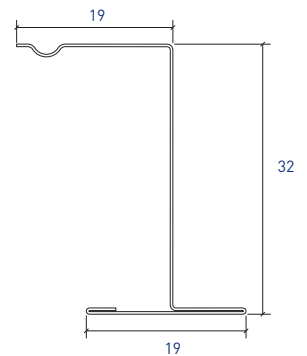

C SECTION

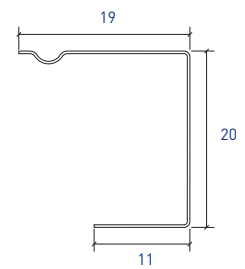

CONCEALED GRID SYSTEMS

The MF suspended system ceilings are ideal for commercial and domestic applications, where services are to be accommodated and when upgrading and protecting existing structures. Ceiling height may be varied to accommodate services or ducting, etc. providing a high performance ceiling with sound insulation and fire protection.

They are compatible with partitioning systems and suitable for direct decoration or textured finish. Always suspend heavy loads, air ducting, lighting units, etc. directly from structural soffit to avoid loading of the suspension framing and always alienate connecting clips on primary channels.

Benefits

- Mineral wool can be incorporated for thermal or acoustic insulation
- Creates a seamless surface suitable to receive most decorative finishes
- Fits easily together
- Suitable for fixing all types of plasterboard
- Creates void above the ceiling for services
- Improved acoustic performances can be achieved by using Acoustic Hangers (see page 19)
- Access to ceiling void can be achieved using Ceiling Access Panels (see page 38 and 39)

MF CEILING COMPONENTS

CEILING FURRING

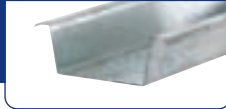

PRODUCT CODE	PRODUCT DESCRIPTION
535370	CEILING FURRING 3600 x 50mm SMF5

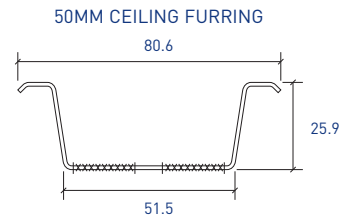

PERIMETER CHANNEL



PRODUCT CODE	PRODUCT DESCRIPTION
535371	PERIMETER CHANNEL 3600mm SMF6A

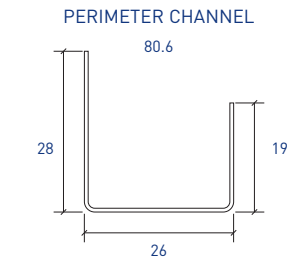

PRIMARY CHANNEL

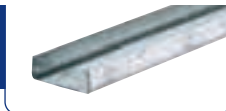

PRODUCT CODE	PRODUCT DESCRIPTION
535372	PRIMARY CHANNEL 3600mm SMF7

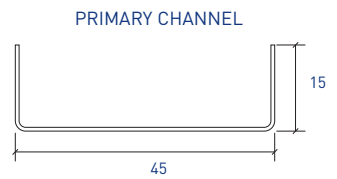

PREFORMED CLIPS



PRODUCT CODE	PRODUCT DESCRIPTION
535373	PREFORMED CLIPS PK200 AMF9



HANGER STRAP



PRODUCT CODE	PRODUCT DESCRIPTION
535374	HANGER STRAP 25,000mm x 25mm COIL MF8

RESILIENT BAR

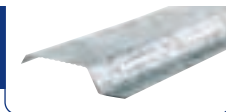

PRODUCT CODE	PRODUCT DESCRIPTION
535409	RESILIENT BAR 3000mm RB565

ANGLE FIXING BRACKETS



PRODUCT CODE	PRODUCT DESCRIPTION
548612	TREETEX ANGLE FIXING CEILING BRACKETS (PACK 100)

CONCEALED GRID SYSTEMS

TEE SECTIONS FOR INSULATING BOARD LINING SYSTEMS



PRODUCT CODE	PRODUCT DESCRIPTION
535385	TEE SECTION 3600 x 25 x 38mm ST06
535386	TEE SECTION 3600 x 32 x 38mm ST08
535387	TEE SECTION 3600 x 38 x 38mm ST010
535388	TEE SECTION 3600 x 25 x 50mm ST12

FISH PLATE FOR INSULATING BOARD LINING SYSTEMS



PRODUCT CODE	PRODUCT DESCRIPTION
535389	FISH PLATE AT01

SLEEVE CONNECTOR FOR INSULATING BOARD LINING SYSTEMS



PRODUCT CODE	PRODUCT DESCRIPTION
535390	SLEEVE CONNECTOR AT03

TALON FIXING CLIP FOR INSULATING BOARD LINING SYSTEMS



PRODUCT CODE	PRODUCT DESCRIPTION
535393	TALON FIX CLIP AT19S
535394	TALON FIX CLIP AT20S

BOARD LINING SYSTEMS AND CONNECTORS

PLASTERBOARD CEILING AND WALL LINER

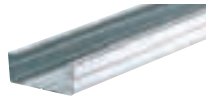

PRODUCT CODE	PRODUCT DESCRIPTION
537307	SGL1 WALL/CEILING LINER 2400mm WL507
535363	SGL1 WALL/CEILING LINER 2700mm WL507
535364	SGL1 WALL/CEILING LINER 3000mm WL507
535365	SGL1 WALL/CEILING LINER 3600mm WL507

PLASTERBOARD CEILING AND WALL LINER – BRACKETS



PRODUCT CODE	PRODUCT DESCRIPTION
535367	SGL2 FIXING BRACKET 75mm LEG AWL03
535368	SGL9 FIXING BRACKET 125mm LEG AWL04

PLASTERBOARD CEILING AND WALL LINER – CONNECTORS

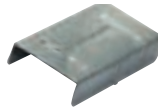

PRODUCT CODE	PRODUCT DESCRIPTION
535369	WALL & CEILING LINER CONNECTOR GL3 50 AWL05
232900	WALL & CEILING LINER SYSTEM TIMBER CONNECTOR 55mm AWL06B
232909	WALL & CEILING LINER SYSTEM TIMBER CONNECTOR 155mm AWL07B

ACOUSTIC HANGERS



PRODUCT CODE	PRODUCT DESCRIPTION
232922	METAL FURRING SYSTEM ACOUSTIC HANGERS 35mm AAH01B

ACOUSTIC HANGERS



PRODUCT CODE	PRODUCT DESCRIPTION
232929	METAL FURRING SYSTEM ACOUSTIC HANGERS 70mm AAH02B

FIRE BARRIER SOLUTIONS



Isolating compartments within a ceiling void is an essential part of controlling the spread of fire. In addition to traditional rockwool, wire faced barriers, CCF provide exclusive distribution of Firefly Fire Barrier Systems and accessories, generally accepted as providing a cleaner, lightweight and easy solution to barrier provision.

FIREFLY – PLUS 30 AND PLUS 60



PRODUCT CODE PRODUCT DESCRIPTION

536901	FIREFLY PLUS30 1300 x 600 x 10mm
536902	FIREFLY PLUS60 1300 x 600 x 10mm

FIREFLY – TITAN



PRODUCT CODE PRODUCT DESCRIPTION

536903	FIREFLY TITAN 1300 x 600 x 15mm
--------	---------------------------------

FIREFLY – 1 ROLL



PRODUCT CODE PRODUCT DESCRIPTION

546142	FIREFLY 1 ROLL 1000 x 10,000mm
546169	FIREFLY 1 ROLL 1000 x 25,000mm

PHOENIX



PRODUCT CODE PRODUCT DESCRIPTION

536895	FIREFLY PHOENIX 1300 x 25,000mm
536896	FIREFLY PHOENIX 1300 x 10,000mm

FLY2



PRODUCT CODE PRODUCT DESCRIPTION

536897	FIREFLY FLY2 1000 x 25,000mm
536898	FIREFLY FLY2 1000 x 10,000mm
536899	FIREFLY FLY2I (2 LAYER) 1000 x 25,000mm

VULCAN



PRODUCT CODE PRODUCT DESCRIPTION

536900	FIREFLY VULCAN 1300 x 600 x 6.5mm
--------	-----------------------------------

FIRE BARRIER SOLUTIONS

COLLAR



PRODUCT CODE	PRODUCT DESCRIPTION
536915	FIREFLY COLLAR 982 x 300mm
536916	FIREFLY FLYCOLLAROLL 10,000 x 300mm

SHIELD



PRODUCT CODE	PRODUCT DESCRIPTION
536917	FIREFLY SHIELD 1300 x 200mm

HIGH TEMPERATURE ADHESIVE



PRODUCT CODE	PRODUCT DESCRIPTION
536918	FIREFLY HIGH TEMPERATURE ADHESIVE

B16 STAPLE GUN



PRODUCT CODE	PRODUCT DESCRIPTION
536919	FIREFLY STAPLE GUN B16

B16 STAPLES

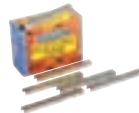

PRODUCT CODE	PRODUCT DESCRIPTION
536922	FIREFLY SS STAPLES 50/8 BOX OF 5000 FOR B16 GUN
536923	FIREFLY SS STAPLES 50/12 BOX OF 5000 FOR B16 GUN
536924	FIREFLY SS STAPLES 50/16 BOX OF 5000 FOR B16 GUN

FIRESHIELD



PRODUCT CODE	PRODUCT DESCRIPTION
546294	FIREFLY PLUS FIRESHIELD 1300 x 200mm

FIREFLY AND MINERAL WOOL BARRIERS

R31 STAPLE GUN



PRODUCT CODE	PRODUCT DESCRIPTION
554988	L083385 FIREFLY STAPLE GUN R31

R31 STAPLES

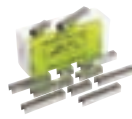

PRODUCT CODE	PRODUCT DESCRIPTION
554990	FIREFLY STAINLESS STEEL STAPLES 8mm 5000 PER BX FOR R31 GUN
554991	FIREFLY STAINLESS STEEL STAPLES 12mm 5000 PER BX FOR R31 GUN

MINERAL WOOL FIRE BARRIER ANGLE AND FLAT STRIP

ANGLE

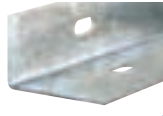

PRODUCT CODE	PRODUCT DESCRIPTION
535361	FIRE BARRIER ANGLE 3000 x 60 x 40mm 1.5G FBAP

FLAT STRIP

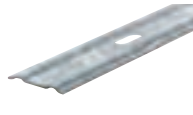

PRODUCT CODE	PRODUCT DESCRIPTION
535362	FIRE BARRIER FLAT STRIP 3000 x 40 x 1.5mm FBFP

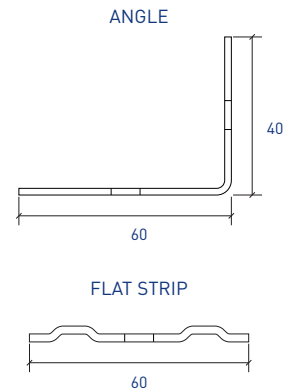

MINERAL WOOL FIRE BARRIERS

PRODUCT CODE	PRODUCT DESCRIPTION
221668	ROCKSILK FIRE BARRIER 50 x 4000mm (900mm) 3.60m ² PER ROLL
221670	ROCKSILK FIRE BARRIER FOIL FACE 1 SIDE 50 x 4000mm (900mm) 3.60m ² PER ROLL

MODULAR LIGHTING SOLUTIONS



The Combi 4 lamp fitting complete with aluminium louvre has long been a popular choice for modular lighting, but the Treetex lighting range does not stop there. High frequency and emergency fittings are also available in three and four lamp options. Treetex also offer a wide choice of surface mount, emergency exit signage, designer and linear lighting solutions for all internal applications. High and low bay units for warehouse use and yard lighting is also available. CCF can also help with lighting schemes to meet all of your requirements.

TREETEX MODULAR LUMINAIRE COMPLETE WITH CAT 2 ALUMINIUM LOUVRE

PRODUCT CODE	PRODUCT DESCRIPTION
547796	TREETEX EUROLITE COMBI RECESSED 663 C2 3 x 18w C/W LOUVRE
547804	TREETEX EUROLITE COMBI RECESSED 663 E3 C2 3 x 18w C/W LOUVRE
547813	TREETEX EUROLITE COMBI RECESSED 663 HF C2 3 x 18w C/W LOUVRE
547850	TREETEX EUROLITE COMBI RECESSED 664 C2 4 x 18w C/W LOUVRE
547862	TREETEX EUROLITE COMBI RECESSED 664 E3 C2 4 x 18w C/W LOUVRE
547870	TREETEX EUROLITE COMBI RECESSED 664 HF C2 4 x 18w C/W LOUVRE
547875	TREETEX EUROLITE COMBI RECESSED 664 HF E3 C2 4x18w C/W LOUVRE
547931	TREETEX EUROLITE COMBI RECESSED 1263 C2 3 x 36w C/W LOUVRE
547941	TREETEX EUROLITE COMBI RECESSED 1263 E3 C2 3 x 36w C/W LOUVRE
547946	TREETEX EUROLITE COMBI RECESSED 1263 HF C2 3 x 36w C/W LOUVRE
547955	TREETEX EUROLITE COMBI RECESSED 1263 HF E3 C2 3 x 36w C/W LOUVRE
547996	TREETEX EUROLITE COMBI RECESSED 1264 C2 4 x 36w C/W LOUVRE
548003	TREETEX EUROLITE COMBI RECESSED 1264 E3 C2 4 x 36w C/W LOUVRE
548011	TREETEX EUROLITE COMBI RECESSED 1264 HF C2 4 x 36w C/W LOUVRE
548016	TREETEX EUROLITE COMBI RECESSED 1264 HF E3 C2 4 x 36w C/W LOUVRE
667124	TREETEX EUROLITE COMBI RECESSED 663 HF E3 C2 3 x 18w C/W LOUVRE

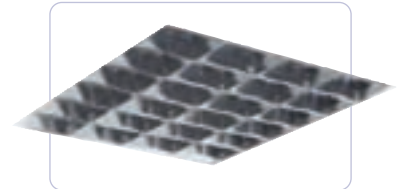

TREETEX MODULAR LUMINAIRE

PRODUCT CODE	PRODUCT DESCRIPTION
546799	TREETEX EUROLITE STANDARD RECESSED 664 4 x 18w C/W GEAR COVER
546806	TREETEX EUROLITE STANDARD RECESSED 664 E3 4 x 18w C/W GEAR COVER
546813	TREETEX EUROLITE STANDARD RECESSED 664 HF 4 x 18w C/W GEAR COVER
546826	TREETEX EUROLITE STANDARD RECESSED 664 HF E3 4 x 18w C/W GEAR COVER
546868	TREETEX EUROLITE STANDARD RECESSED 1264 4 x 36w C/W GEAR COVER
546877	TREETEX EUROLITE STANDARD RECESSED 1264 E3 4 x 36w C/W GEAR COVER
546881	TREETEX EUROLITE STANDARD RECESSED 1264 HF 4 x 36w C/W GEAR COVER
546890	TREETEX EUROLITE STANDARD RECESSED 1264 HF E3 4 x 36w C/W GEAR COVER

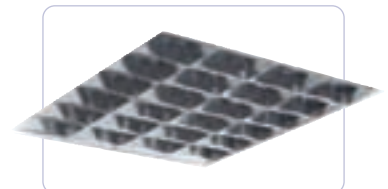

MODULAR LIGHTING SOLUTIONS

TREETEX ALUMINIUM LIGHTING LOUVRES

PRODUCT CODE	PRODUCT DESCRIPTION
547419	TREETEX ALUMINIUM LIFT & TILT LOUVRE 664 T15 LB
547464	TREETEX ALUMINIUM LIFT & TILT LOUVRE 664 T24 LB
547503	TREETEX ALUMINIUM LIFT & TILT LOUVRE 664 T15 C2
547539	TREETEX ALUMINIUM LIFT & TILT LOUVRE 664 T24 C2
548109	TREETEX ALUMINIUM LIFT & TILT LOUVRE 1264 T15 LB
548136	TREETEX ALUMINIUM LIFT & TILT LOUVRE 1264 T24 LB
548155	TREETEX ALUMINIUM LIFT & TILT LOUVRE 1264 T15 C2
548185	TREETEX ALUMINIUM LIFT & TILT LOUVRE 1264 T24 C2

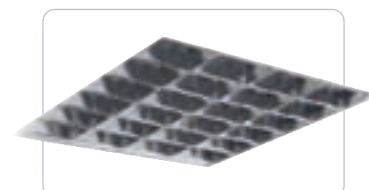

FLUORESCENT LAMPS FOR TREETEX LUMINAIRES

PRODUCT CODE	PRODUCT DESCRIPTION
545731	FLUORESCENT LAMP 600mm (2ft) 18w T8 STANDARD WHITE 3500
545779	FLUORESCENT LAMP 1200mm (4ft) 36w T8 STANDARD WHITE 3500
545802	FLUORESCENT LAMP 1500mm (5ft) 58w T8 STANDARD WHITE 3500
545830	FLUORESCENT LAMP 1800mm (6ft) 70w T8 STANDARD WHITE 3500



LIGHTING YOKES FOR MODULAR CEILINGS

PRODUCT CODE	PRODUCT DESCRIPTION
547437	TIMBER TRIMS PLYWOOD YOKES 595 x 595 x 6mm WITH HOLE TT004
547509	TIMBER TRIMS PLYWOOD YOKES 595 x 595 x 12mm WITH HOLE TT006
547580	TIMBER TRIMS PLYWOOD YOKES 595 x 595 x 9mm WITH HOLE TT008
547725	PLYWOOD YOKES FIRE RATED CLASS 1 595 x 595 x 6mm WITH HOLE
547768	PLYWOOD YOKES FIRE RATED CLASS 0 595 x 595 x 12mm WITH HOLE
547478	TIMBER TRIMS PLYWOOD YOKES 595 x 595 x 6mm NO HOLE TT005
547543	TIMBER TRIMS PLYWOOD YOKES 595 x 595 x 12mm NO HOLE TT007
547611	TIMBER TRIMS PLYWOOD YOKES 595 x 595 x 9mm NO HOLE TT010
547748	TIMBER TRIMS PLYWOOD YOKES FIRE RATED CLASS 0 595 x 595 x 6mm WITH HOLE TT011
547763	TIMBER TRIMS PLYWOOD YOKES FIRE RATED CLASS 0 595 x 595 x 6mm NO HOLE TT012

OTHER TREETEX LIGHTING AVAILABLE FROM CCF

All with a choice of control gear and lamp configurations

Combi Fast Fix

Surface mounted fittings

Designer range

Universal

Designer T5

Zenith

Emergency exit signage lighting

Low bay

High bay

Yard lighting



MODULAR LIGHTING SOLUTIONS

TREETEX PRISMATIC DIFFUSERS – PRISMATIC CLEAR DIFFUSER

PRODUCT CODE PRODUCT DESCRIPTION

546247	SLP PRISMATIC CLEAR DIFFUSER 600 x 600 x 2.5mm P12-25-STY-C-600
546345	SLP PRISMATIC CLEAR DIFFUSER 1200 x 600 x 2.5mm P12-25-STY-C-1200

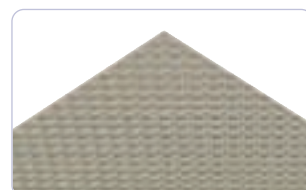

TREETEX PRISMATIC DIFFUSERS – PRISMATIC OPAL DIFFUSER

PRODUCT CODE PRODUCT DESCRIPTION

546296	SLP PRISMATIC OPAL DIFFUSER 600 x 600 x 2.5mm P12-25-STY-O-600
546415	SLP PRISMATIC OPAL DIFFUSER 1200 x 600 x 2.5mm P12-25-STY-O-1200

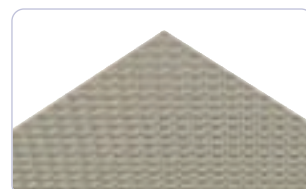

TREETEX PRISMATIC DIFFUSERS – ACRYLIC CLEAR PRISMATIC

PRODUCT CODE PRODUCT DESCRIPTION

546794	SLP ACRYLIC CLEAR PRISMATIC 600 x 600 x 3mm P12-30-ACR-C-600
546804	SLP ACRYLIC CLEAR PRISMATIC 1200 x 600 x 3mm P12-30-ACR-C-1200
546817	SLP ACRYLIC CLEAR PRISMATIC 1800 x 600 x 3mm P12-30-ACR-C-1800

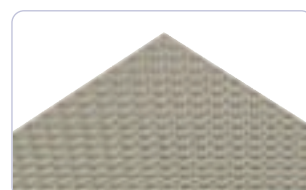

EGG CRATE LOUVRES

PRODUCT CODE PRODUCT DESCRIPTION

546891	WHITE STYRENE OPAL (EGG CRATE) LOUVRE 600 x 600mm 15 x 15 x 8 CELL
547563	WHITE ALUMINIUM (EGG CRATE) LOUVRE 600 x 600mm 13 x 13 x 13 CELL

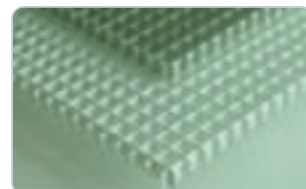
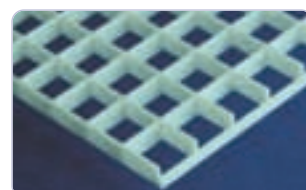

PRISMATIC DIFFUSERS AND FIRE CANOPIES

FIREFLY MODULAR LIGHTING FIRE CANOPIES

PRODUCT CODE	PRODUCT DESCRIPTION
536904	FIREFLY FIRE CANOPY 300 x 300 x 150mm
536905	FIREFLY FIRE CANOPY 600 x 300 x 150mm
536906	FIREFLY FIRE CANOPY 600 x 600 x 150mm
536907	FIREFLY FIRE CANOPY 1200 x 300 x 150mm
536908	FIREFLY FIRE CANOPY 1200 x 600 x 150mm



FIREFLY DOWNLIGHTER CANOPIES

PRODUCT CODE	PRODUCT DESCRIPTION
536909	FIREFLY DOWNLIGHT COVER 150 x 170mm
536910	FIREFLY DOWNLIGHT COVER 200 x 200 x 230mm
536911	FIREFLY DOWNLIGHT COVER 260 x 260 x 230mm
536912	FIREFLY DOWNLIGHT COVER 300 x 300 x 350mm
536913	FIREFLY DOWNLIGHT COVER 350 x 350 x 230mm
536914	FIREFLY DOWNLIGHT COVER 600 x 600 x 230mm



ALUMINIUM PERIMETER TRIMS AND TRANSITION PROFILES



Joining different materials at ceiling junctions can be a problem e.g. mineral fibre tiles in exposed grid systems to MF plasterboard system. To help overcome this CCF offer a range of aluminium profiles to join most types of materials used in ceiling applications.

ALUMINIUM PERIMETER TRIMS AND TRANSITION PROFILES

ALUMINIUM PERIMETER TRIM PROFILES

PRODUCT CODE	PRODUCT DESCRIPTION
545553	TCA0101 PERIMETER TRIM 3000mm
545334	TCA0108 PERIMETER CHANNEL 20 x 38 x 3000mm
545791	TCA0110 ODDLEG TRIM 20 x 60 x 3000mm
545963	TCA0124 SHADOWGAP CHANNEL 20 x 15 x 15 x 45 x 3000mm
545447	TCA0128 90DEG SHADOWGAP CHANNEL 20 x 20 x 20 x 40 x 3000mm
546075	TCA0133 SHADOWGAP CHANNEL 25 x 25 x 40 x 3000mm
546164	TCA0141 TILE TRIM 20 x 14 x 15 x 14 x 6 x 3000mm
546234	TCA0152 BOARD TRIM (12.5mm BOARD) 6 x 16 x 30 x 3000mm

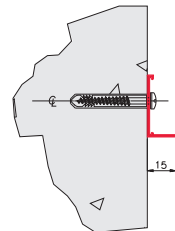

ALUMINIUM TEE PROFILES

PRODUCT CODE	PRODUCT DESCRIPTION
546556	TCA0204 FLAT TEE 25 x 38 x 3000mm
546590	TCA0207 FLAT TEE 30 x 38 x 3000mm
546604	TCA0209 FLAT TEE 39 x 38 x 3000mm
546151	TCP180 STRAIGHT SPLICE PLATE STEEL
546195	TCP90 CORNER SPLICE PLATE

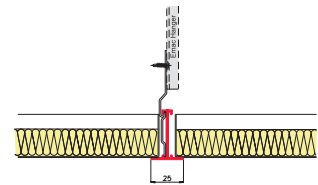

METAL TILE TO PLASTERBOARD TRANSITIONS

PRODUCT CODE	PRODUCT DESCRIPTION
548049	TRU-MJ-150 FEATHERED METAL TILE 25 x 20 x 53mm
548112	TRU-SG-150 FEATHERED METAL TILE 46 x 43mm
544105	TRU-SJ-1516 FEATHERED METAL TILE 25 x 16 x 40mm
548188	TRU-SS-150 FEATHERED METAL TILE 31 x 43mm
548214	TRU-ST-150 15mm SHADOWGAP TRIM 25 x 15 x 25mm
548264	TRU-TJ-1516 FEATHERED THREADED METAL TILE 25 x 17 x 40mm
544128	TRUSJ150 TRUFORM CEILING SHADOW GAP JUNCTION TRIM 3000mm
544164	TRUST150 TRUFORM CEILING PERIM SHADOWGAP TRIM 3000mm
544234	TRUSJT1508 CEILING SHADOWGAP TRANSITION TRIM FOR EMAC130T15
544293	TRUTJ1516 FEATHERED THREADED METAL TILE / PLASTERBOARD TRIM 3000mm

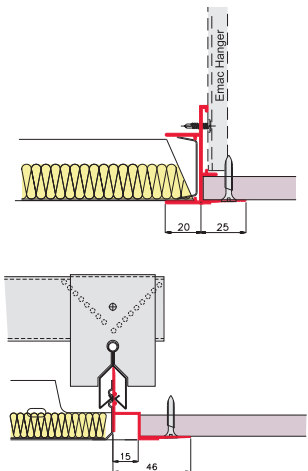

SHADOW BATTENS

When that little bit of extra detail is required at the ceiling perimeter, Treetex shadow battens may be the answer. Available in pre-drilled MDF or timber lengths, the products are normally painted black but can be supplied in white as well.

EXPOSED GRID PERIMETER FEATURES – MDF SHADOW BATTEN

PRODUCT CODE	PRODUCT DESCRIPTION
--------------	---------------------

547199	MDF SHADOW BATTEN BLACK 2440 x 38 x 18mm TT001
--------	--

547253	MDF SHADOW BATTEN BLACK 2440 x 38 x 25mm TT003
--------	--

EXPOSED GRID PERIMETER FEATURES – TIMBER SHADOW BATTEN

PRODUCT CODE	PRODUCT DESCRIPTION
--------------	---------------------

547644	TIMBER SHADOW BATTEN BLACK 2 x 1 3000mm LENGTHS
--------	---

547656	TIMBER SHADOW BATTEN WHITE 2 x 1 3000mm LENGTHS
--------	---



PRIMARY SUSPENSION SYSTEMS

CCF supply Metstrut primary suspension to meet the needs of heavy duty suspension. Ideal for pipes, ducting and cableways, the channel sections are available with all nuts, brackets and threaded rods to complete the system.

PRE GALVANISED

PRODUCT CODE	PRODUCT DESCRIPTION
544134	PLAIN CHANNEL 41 x 41 x 2.5 x 3000mm MS4125PG3
544184	SLOTTED (S14) CHANNEL 41 x 41 x 2.5 x 3000mm MS4125PG3S14
544240	PLAIN CHANNEL 41 x 21 x 2.5 x 3000mm MS2125PG3
544283	SLOTTED (S14) CHANNEL 41 x 21 x 2.5 x 3000mm MS2125PG3S14
544300	SLOTTED (S14) CHANNEL 41 x 41 x 2.5 x 6000mm MS4125PG6S14
544357	SLOTTED (S14) CHANNEL 41 x 41 x 1.5 x 3000mm MS4115PG3S14
544411	PLAIN CHANNEL 41 x 21 x 1.5 x 3000mm MS2115PG3
544459	SLOTTED (S14) CHANNEL 41 x 21 x 1.5 x 3000mm MS2115PG3S14

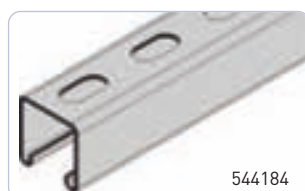
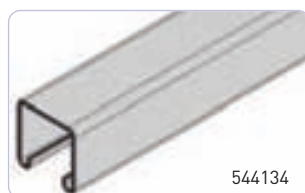
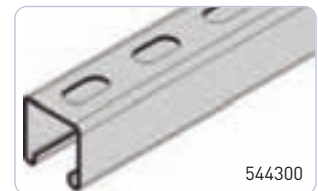

CEILING FIXINGS AND ACCESSORIES



Treetex offers a complete range of ceiling fixing accessories. These include appropriate suspension top fixings for timber, concrete or metal purlins. In addition to the Treetex range, CCF also offer a comprehensive range of fixings to meet the needs of general interior building fit outs. Ask your local CCF branch for details.

ACOUSTIC HANGERS



PRODUCT CODE PRODUCT DESCRIPTION

232922	METAL FURRING SYSTEM ACOUSTIC HANGERS 35mm AAH01B
--------	---

ACOUSTIC HANGERS



PRODUCT CODE PRODUCT DESCRIPTION

232929	METAL FURRING SYSTEM ACOUSTIC HANGERS 70mm AAH02B
--------	---

WEDGE NUTS AND BOLTS

PRODUCT CODE PRODUCT DESCRIPTION

544275	STANDARD 6mm WEDGE NUTS (BOX 100)
544135	EYELET BOLTS (FOR USE WITH WEDGE NUT) 6 x 80mm (BOX 100)

CEILING FIXINGS AND ACCESSORIES

WIREHANGER

PRODUCT CODE	PRODUCT DESCRIPTION
543928	TREETEX 6 x 60mm WIREHANGER (BOX 100)



ANGLE FIXING CEILING BRACKET

PRODUCT CODE	PRODUCT DESCRIPTION
548612	TREETEX ANGLE FIXING CEILING BRACKET (PACK 100)



VERTICAL FLANGE CLIP

PRODUCT CODE	PRODUCT DESCRIPTION
543465	TREETEX BF1 1.5 x 4mm VERTICAL FLANGE CLIP (BOX 100)



VERTICAL CLIP

PRODUCT CODE	PRODUCT DESCRIPTION
548703	TREETEX BVF1 1.6 TO 2.5 mm VERTICAL CLIP



PURLIN HANGERS

PRODUCT CODE	PRODUCT DESCRIPTION
784045	TREETEX BF14 PURLIN HANGERS (BOX 100)

CEILING FIXINGS AND ACCESSORIES

VINE EYE

PRODUCT CODE	PRODUCT DESCRIPTION
544315	TREETEX 6 x 75mm VINE EYE (BOX 100)



FLANGE FASTENER

PRODUCT CODE	PRODUCT DESCRIPTION
543398	TREETEX BE 1-2 FLANGE FASTENER (PACK 10)
543422	TREETEX BE 2-4 FLANGE FASTENER (PACK 10)
543442	TREETEX BE 5-8 FLANGE FASTENER (PACK 10)



TWIST FASTENER

PRODUCT CODE	PRODUCT DESCRIPTION
548679	TREETEX BMA 4-16 TWIST FASTENER (BOX 100)



SIGN HANGER 10KG

PRODUCT CODE	PRODUCT DESCRIPTION
543349	TREETEX BA 4-16H SIGN HANGER WHITE 10kg LOAD (PACK 10)



SIGN HANGER 3.5KG

PRODUCT CODE	PRODUCT DESCRIPTION
543377	TREETEX WIRE SIGN HANGER 3.5kg LOAD (BOX 100)

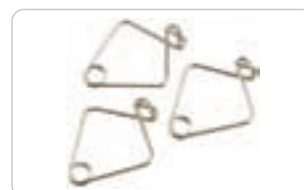

CEILING FIXINGS AND ACCESSORIES

CEILING GRID SUSPENSION WIRE

PRODUCT CODE	PRODUCT DESCRIPTION
546541	GALVANISED SUSPENSION WIRE 2.0mm DIA 4kg COIL 150m



TEG BLOCKS

PRODUCT CODE	PRODUCT DESCRIPTION
547344	GRID FIX BLOCKS WIDE T24 SHALLOW 500 PER BAG PART NO.008
547370	GRID FIX BLOCKS WIDE T24 STANDARD 500 PER BAG PART NO.007
547349	GRID FIX BLOCKS NARROW T15 SHALLOW 500 PER BAG PART NO.006
547377	GRID FIX BLOCKS NARROW T15 STANDARD 500 PER BAG PART NO.005



THREADED ROD

PRODUCT CODE	PRODUCT DESCRIPTION
544179	TRADELIN 6 x 3000mm THREADED ROD
544189	TRADELIN 8 x 3000mm THREADED ROD



THREADED ROD COUPLER

PRODUCT CODE	PRODUCT DESCRIPTION
544235	TRADELIN 6mm THREADED ROD COUPLER (BOX 10)
544244	TRADELIN 8mm THREADED ROD COUPLER (BOX 10)



ACCESS PANELS



No matter if your needs are for ceiling or wall access panels, within the Treetex range guide is a comprehensive selection of Exitile products. Other Exitile products are also available.



CEILING ACCESS PANELS

ACCESS PANELS FOR USE WITH EXPOSED GRID SYSTEMS

PRODUCT CODE	PRODUCT DESCRIPTION
547105	EX/EG EXITILE 600 x 600mm T15 /T24 GRID FLAT SE TILE SYSTEMS
547168	EX/EG EXITILE 600 x1200mm T15 / T24 EXPOSED GRID FLAT SE TILE SYSTEMS
547708	EX/EG EXITILE 600 x 600mm T24 TEG 24mm EXPOSED GRID SYSTEMS
547782	EX/EG EXITILE 600 x 1200mm T24 TEG EXPOSED GRID T24 TEGULAR SYSTEMS



ACCESS PANELS WITH METAL DOORS FOR CEILINGS OR WALLS

PRODUCT CODE	PRODUCT DESCRIPTION
545373	EX/XL/PF EXITILE 300 x 300mm METAL DOOR PICTURE FRAME BUDGET LOCK
545469	EX/XL/PF EXITILE 450 x 450mm METAL DOOR PICTURE FRAME BUDGET LOCK
545639	EX/XL/PF EXITILE 600 x 600mm METAL DOOR PICTURE FRAME BUDGET LOCK
545435	EX/XL/SB EXITILE 300 x 300mm METAL DOOR BEADED FRAME BUDGET LOCK
545552	EX/XL/SB EXITILE 450 x 450mm METAL DOOR BEADED FRAME BUDGET LOCK
545665	EX/XL/SB EXITILE 600 x 600mm METAL DOOR BEADED FRAME BUDGET LOCK
543487	EX/WD/PF EXITILE 300 x 300mm METAL DOOR PICTURE FRAME PANEL
543511	EX/WD/PF EXITILE 450 x 450mm METAL DOOR PICTURE FRAME PANEL
543530	EX/WD/PF EXITILE 600 x 600mm METAL DOOR PICTURE FRAME PANEL
543581	EX/WD/SB EXITILE 300 x 300mm METAL DOOR BEADED FRAME PANEL
543609	EX/WD/SB EXITILE 450 x 450mm METAL DOOR BEADED FRAME PANEL
543634	EX/WD/SB EXITILE 600 x 600mm METAL DOOR BEADED FRAME PANEL



FIRE RATED ACCESS PANELS

PRODUCT CODE	PRODUCT DESCRIPTION
543925	EX/WD/PF/FD EXITILE 300 x 300mm 1FR METAL DOOR PICTURE FRAME
543944	EX/WD/PF/FD EXITILE 450 x 450mm 1FR METAL DOOR PICTURE FRAME
543965	EX/WD/PF/FD EXITILE 600 x 600mm 1FR METAL DOOR PICTURE FRAME
544009	EX/WD/SB/FD EXITILE 300 x 300mm 1FR METAL DOOR BEADED FRAME
544030	EX/WD/SB/FD EXITILE 450 x 450mm 1FR METAL DOOR BEADED FRAME
544051	EX/WD/SB/FD EXITILE 600 x 600mm 1FR METAL DOOR BEADED FRAME



LASER LEVELS AND TEMPORARY SURFACE PROTECTION

For an accurate level when beginning installations, you need a quality laser level. CCF offer a range of high quality Topcon interior laser levels to suit most budgets and applications. We can also help with repairs and servicing, particularly on the more complex laser models. Other laser levels available on request.



TOPCON LASER LEVELS

PRODUCT CODE	PRODUCT DESCRIPTION
160082	RLVH4G ROTATING GREEN BEAM LASER LEVEL
548621	RLVH3D ROTATING RED BEAM LASER LEVEL
160094	PLS180 CROSS BEAM LASER LEVEL

Temporary protective sheeting is a standard product to CCF but in addition we can supply a variety of products to help protect surfaces during building refurbishments.

TEMPORARY POLYTHENE PROTECTIVE SHEET

PRODUCT CODE	PRODUCT DESCRIPTION
780941	TEMPORARY POLYTHENE PROTECTIVE SHEET 4 x 50,000mm 8kg MEDIUM DUTY



ACOUSTIC INSULATION PADS FOR METAL TILE SYSTEMS

Perforated metal tiles often require insulation to help achieve the desired acoustic performance. A range of sizes and densities are available from the Treetex range.

INSULATION PADS BLACK

PRODUCT CODE	PRODUCT DESCRIPTION
547965	INSULATION PADS BLACK POLYTHENE 600 x 600 x 60mm
548026	INSULATION PADS BLACK POLYTHENE 600 x 600 x 100mm
548050	INSULATION PADS BLACK POLYTHENE 600 x 600 x 150mm
548086	INSULATION PADS BLACK POLYTHENE 600 x 600 x 200mm
492140	INSULATION PADS BLACK POLYTHENE R/W 600 x 600 x 25mm
548209	INSULATION PADS BLACK POLYTHENE R/W 600 x 600 x 30mm 45kg
548239	INSULATION PADS BLACK POLYTHENE R/W 600 x 600 x 50mm 45kg
548296	INSULATION PADS BLACK POLYTHENE R/W 600 x 600 x 100mm 23kg
548371	INSULATION PADS BLACK POLYTHENE 1200 x 600 x 150mm
545851	INSULATION PADS BLACK POLYTHENE 1200 x 600 x 100mm

OTHER CREATIVE CEILING SOLUTIONS FROM CCF

CCF can also help provide solutions for the more unusual project. These include mirror ceiling panels, translucent ceiling thermal panels, curved ceiling solutions – both at perimeter and in ceiling plane, column casings and ceiling and wall acoustic baffles. For those that want to get their advertising message or company logo onto their ceiling we can even supply printed ceiling panels. If you don't see what you want, just ask at your local CCF branch. We want to help you find solutions for all of your interior build requirements.

- **Mirror ceiling panels**
- **Translucent thermal panels**
- **Curved ceiling solution**
- **Column casings**
- **Ceiling and wall acoustic absorbers**
- **Printed ceiling panels**

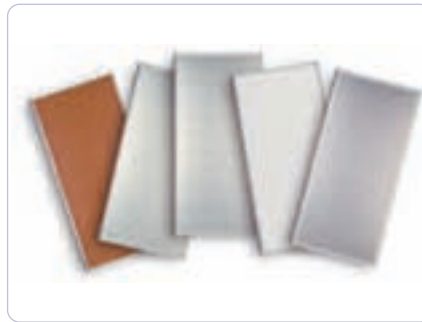

CONTACT YOUR LOCAL BRANCH FOR MORE INFORMATION:

Ashford

01233 611135

Barking

020 8526 8700

Basildon

01268 293323

Birmingham

0121 525 8877

Bristol

0117 982 2613

Cannock

01543 686998

Cardiff

029 2076 3311

Carlisle

01228 672257

Christchurch

01202 496666

Croydon

020 8665 6113

Doncaster

01302 786043

East Kilbride

01355 244400

East London

020 7540 5050

Edinburgh

0131 440 4023

Exeter

01392 362128

Glasgow

0141 445 2557

Heathrow

020 8893 5353

Leeds

0113 270 4400

SLBM Waterside**Leeds**

08700 979797

SLBM Bridgewater**Rd Leeds**

08707 550677

Liverpool

0151 933 8444

Manchester

0161 877 4088

Newcastle

0191 491 4992

Nottingham

01773 711404

Park Royal

020 8965 4222

Peterborough

01733 551333

Plymouth

01752 893547

Portsmouth

023 9241 3770

Reading

0118 949 2540

Southampton

01489 785155

Stevenage

01438 740055

Swindon

01793 497580

Thetford

01842 766316

West London

020 8810 5533

Head Office

27-28 Suttons
Business Park,
London Road,
Reading,
Berkshire, RG6 1AZ

Email:
ccf@ccfltd.co.uk

www.ccfltd.co.uk

The information (including prices) contained in this publication is believed to be correct and complete at the time of printing. Due to limitations in the printing process images may not be representative of their true colours. Stock may vary from branch to branch and is subject to availability. All photographs are as a guide only and do not necessarily represent the products available. CCF reserves the right to change product details without prior notice. E&OE. November 2007. J8016 11/07

TREETEX

CCF CEILING SOLUTIONS